

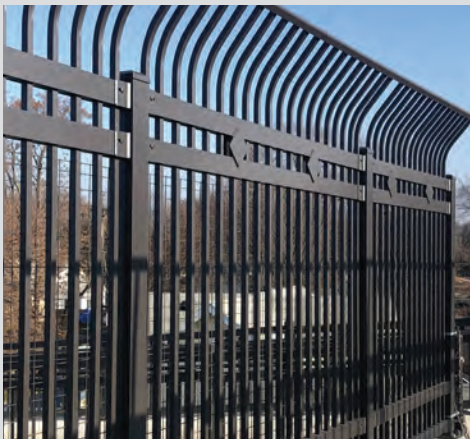

Introduces
COREGard™
ARCHITECTURAL PRODUCTS



Buy American, Be American™ 

50925 Richard W. Blvd. | Chesterfield Twp., MI 48051

Phone (586) 468-4448 | Fax (586) 468-4884

1.800.783.1331 | www.EliteFence.com





Our **CORE** Advantages:

- **Family-Owned for 40 Years**

In an industry increasingly controlled by financial institutions and large multi-national corporations, Elite is still a family owned & operated business that puts the customer first.

- **Made in America**

We not only produce our products in the US, we also source locally to help ensure quality and protect American jobs. "Built right. Built here"

- **In-House Fabrication**

Whether it's fence, railing, gate hardware or one-off custom signs, we utilize the latest technology to manufacture and powder-coat virtually all our products in our MI facility to ensure quality.

- **Submittal Process**

From pre-construction specifications and shop drawings to test reports and product samples, we supply the tools necessary to help you secure your next commercial project.

- **Focus on Value**

While other companies sacrifice quality & reputation in order to continue the "race to the bottom" with pricing, our focus is on VALUE and producing a professional-grade product.

- **Multiple Locations**

We can service our customers from either of our 3 locations in Florida, Tennessee or our corporate facility in Michigan.

- **Knowledgeable Team**

Whether it's production employees, administrative staff or members of our sales/customer service department, Elite is proud to have a veteran team of dedicated people to service our customers, including many with decades of experience in the industry.

Family Values. American Craftsmanship.

50925 Richard W. Blvd. | Chesterfield Twp., MI 48051
Phone (586) 468-4448 | Fax (586) 468-4884

1.800.783.1331 | www.EliteFence.com

Table of Contents

PAGES

AXIS™ 4-5
GATE HINGES

BRIDGEgard™ 6-7
RAILING SYSTEMS

ENTRYgard™ 8-9
ENGINEERED GATE/DOOR SYSTEMS

FALLgard™ 10-11
PERIMETER FENCE SYSTEMS

LIFEGard™ 12-13
PERIMETER FENCE SYSTEMS

CORErailing™ 14-15
ASSEMBLED RAILING SYSTEMS

LEGACY 158 16-17
ALUMINUM RAILING SYSTEMS

LEGACY 250 18-19
ALUMINUM RAILING SYSTEMS

PAGES

PRIVACYgard™ 20-21
ALUMINUM T&G

PRIVACYgard™ 22-23
H.A.S.P.

PRIVACYgard™ 24-25
HYBRID

PRIVACYgard™ 26-27
LOUVERED

PRIVACYgard™ 28-29
DUMPSTER SURROUNDS

SAFETYgard™ 30-31
RAILING SYSTEMS

RAPID ROCK® 32
ANCHORING CEMENT

50925 Richard W. Blvd. | Chesterfield Twp., MI 48051
Phone (586) 468-4448 | Fax (586) 468-4884

1.800.783.1331 | www.EliteFence.com













AXIS™ GATE HINGES

Elite's exclusive line of **AXIS Gate Hinges** includes configurations for virtually any application as well as custom options. Our hinges are engineered/fabricated in-house out of the highest quality materials and are available in all 10 of our powder coat colors.

Engineered & Tested for Performance!

AXIS Gate Hinges Colors:

 Textured (Matte) Black	 Black	 Beige**
 Textured (Matte) White	 White	 Hartford Green**
 Textured (Matte) Quaker Bronze	 Quaker Bronze	 Walnut Brown**
 Textured (Matte) Sandstone	 Sandstone**	Colors shown are simulated and may vary.

**These colors have extended lead times

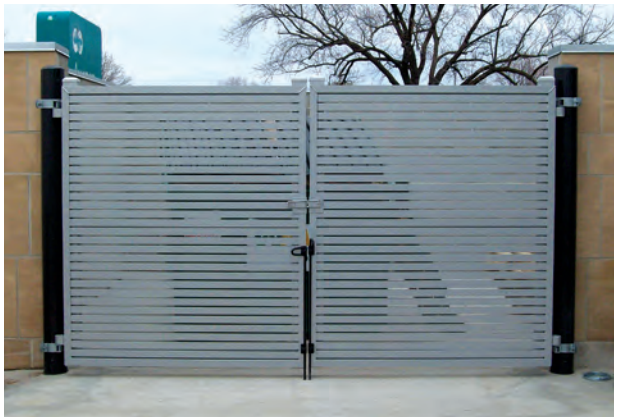

Buy American, Be American™ 

1.800.783.1331 | www.EliteFence.com



All AXIS hinges are available color-matched. Ask us about other configurations & custom options.



6" XTR



6" XTR 180



6" XTR Adjustable



4" XTR



4" XTR 180

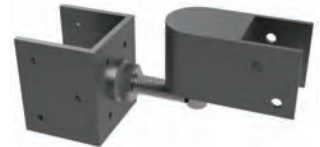

4" XTR Adjustable



MAX Wall-Mount

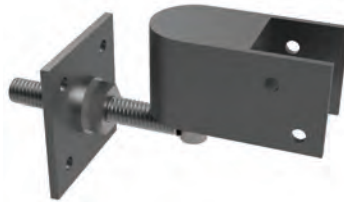

MAX Adjustable



PRO 180 XL



PRO 180



STD



STD Wall-Mount



ECO-FRIENDLY



WIND/WEATHER RESISTANT



POWDER COATED AAMA 2604-05



LOW MAINTENANCE



LIMITED LIFETIME WARRANTY



BUY AMERICAN BE AMERICAN





BRIDGEgard™ - ENGINEERED PEDESTRIAN RAILING SYSTEMS

When safety and security matter most, **Elite's BRIDGEgard Railing Systems** deliver dependable performance. Part of the **Elite COREgard Architectural Products** brand of **Elite Fence Products**, BRIDGEgard pedestrian bridge railings are engineered from heavy-duty aluminum components, including rails, pickets, and posts built for demanding environments. The system features robust 2" x 3-1/2" rails, 1" x 1" pickets and 4" x 4" posts for exceptional strength and stability. Custom architectural elements can also be produced to achieve a distinctive, tailored look.

Designed for long-lasting performance, BRIDGEgard railings resist rust, warping and cracking, all without the need for painting or ongoing maintenance. BRIDGEgard railings are powder coated to exceed AAMA 2604 standards for superior durability. BRIDGEgard pedestrian railings are fully tested and backed by a limited lifetime warranty.

- **Engineered for TESTED Performance**
- **Meets AASHTO LRFD* Requirements**
**(American Association of State Highway Transportation Officials) (Load and Resistance Factor Design)*
- **3-Part Submittals Available**
- **Primary Application: Pedestrian Railing for Bridges**

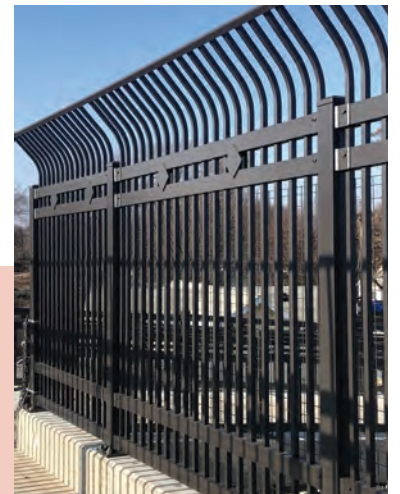

Buy American, Be American™ 

1.800.783.1331 | www.EliteFence.com













BRIDGEgard™ - ENGINEERED PEDESTRIAN RAILING SYSTEMS

BRIDGEgard Specs*:

Width:	Multiple Sized Panels
Heights:	3' - 8'
Min. Strength:	35,000 psi
Alum. Alloy:	6005-T5 Alloy (Rails & Posts)
Posts:	4" x 4" .325 Wall
Pickets:	1" x 1" .062 Wall

*These are the standard specifications. Custom designs may vary.

BRIDGEgard Colors:

 Textured (Matte) Black	 Black	 Beige**
 Textured (Matte) White	 White	 Hartford Green**
 Textured (Matte) Quaker Bronze	 Quaker Bronze	 Walnut Brown**
 Textured (Matte) Sandstone	 Sandstone**	Colors shown are simulated and may vary.

**These colors have extended lead times

BRIDGEgard Resources:

Specifications, Drawings, Testing/Engineering, Brochure and Warranty

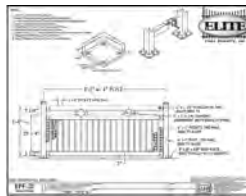

BRIDGEgard Profiles:

These are examples of typical profiles:

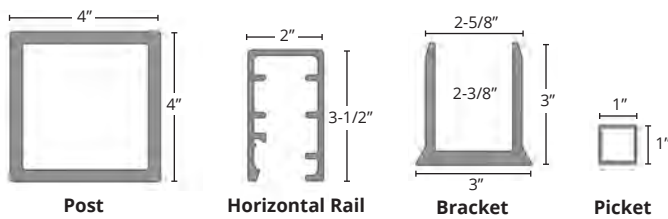

BRIDGEgard Components:

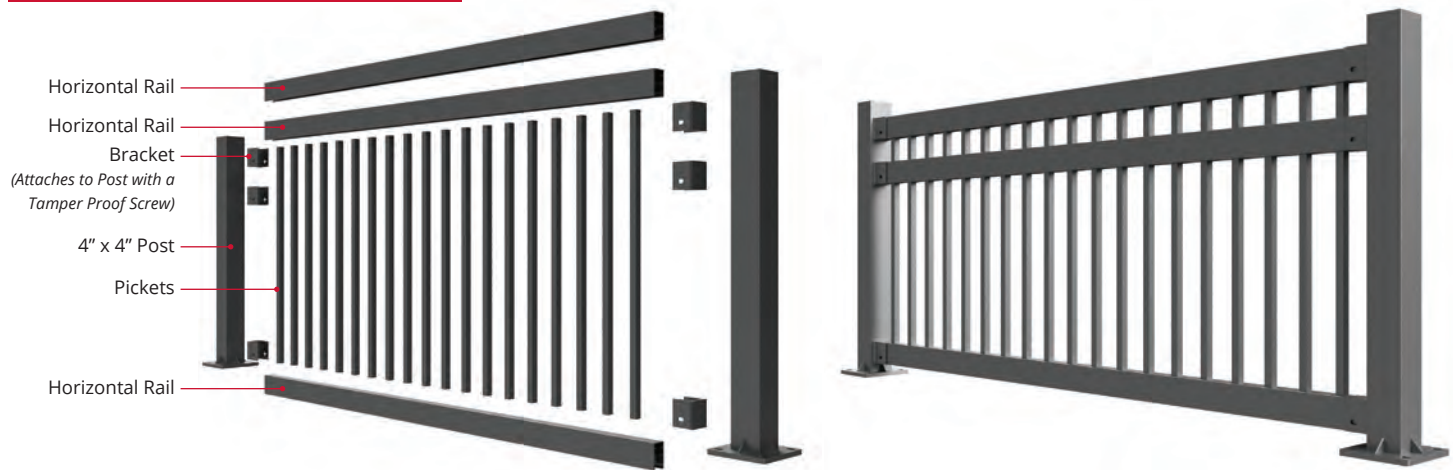

ECO-FRIENDLY



WIND/WEATHER RESISTANT



POWDER COATED
AAMA 2604-05



LOW MAINTENANCE



LIMITED LIFETIME WARRANTY



BUY AMERICAN
BE AMERICAN

ELITE
COREgard
ARCHITECTURAL PRODUCTS

50925 Richard W. Blvd. | Chesterfield Twp., MI 48051
Phone (586) 468-4448 | Fax (586) 468-4884
1.800.783.1331 | www.EliteFence.com





ENTRYGard™ – ENGINEERED GATE/DOOR SYSTEMS

When safety and security are critical, **Elite's ENTRYGard** gate/door systems provide reliable, high-performance solutions. As part of the **Elite COREGard Architectural Products** brand of **Elite Fence Products**, ENTRYGard pedestrian gates are constructed from heavy-duty aluminum components designed to withstand demanding environments and climates. These doors/gates ship fully assembled and are available with pre-installed commercial-grade door hardware and various configurations of protective mesh.

Built for long-term durability, ENTRYGard railings resist rust, warping and cracking, eliminating the need for painting or ongoing maintenance. Each system is powder coated to exceed AAMA 2604 standards, ensuring exceptional finish performance. ENTRYGard doors/gates are engineered for critical infrastructure and are rigorously tested and backed by a limited warranty.

- **Engineered & Tested for Performance**
- **Multiple Hardware Options Available**
- **3-Part Submittals Available**
- **Applications Include: Municipal Buildings, Schools & Universities, Stadiums & Entertainment Complexes, Data Centers & Utility Companies, Apartment and Assisted Living Properties**



Buy American, Be American™ 

1.800.783.1331 | www.EliteFence.com













ENTRYGard™ GATE/DOOR SYSTEMS

ENTRYGard Specs:

Width:	Custom
Heights:	Custom
Min. Strength:	35,000 psi
Alum. Alloy:	6005-T5 Alloy (Rails & Posts)
Other:	Available as Single and Double Gates/Doors and Left or Right Hand Swing

ENTRYGard Colors:

	Textured (Matte) Black		Black		Beige**
	Textured (Matte) White		White		Hartford Green**
	Textured (Matte) Quaker Bronze		Quaker Bronze		Walnut Brown**
	Textured (Matte) Sandstone		Sandstone**	Colors shown are simulated and may vary.	

**These colors have extended lead times

ENTRYGard Resources:

Specifications, Drawings, Testing/Engineering, Brochure and Warranty

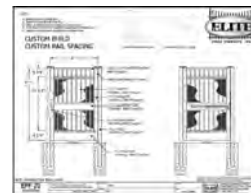

ENTRYGard Components:

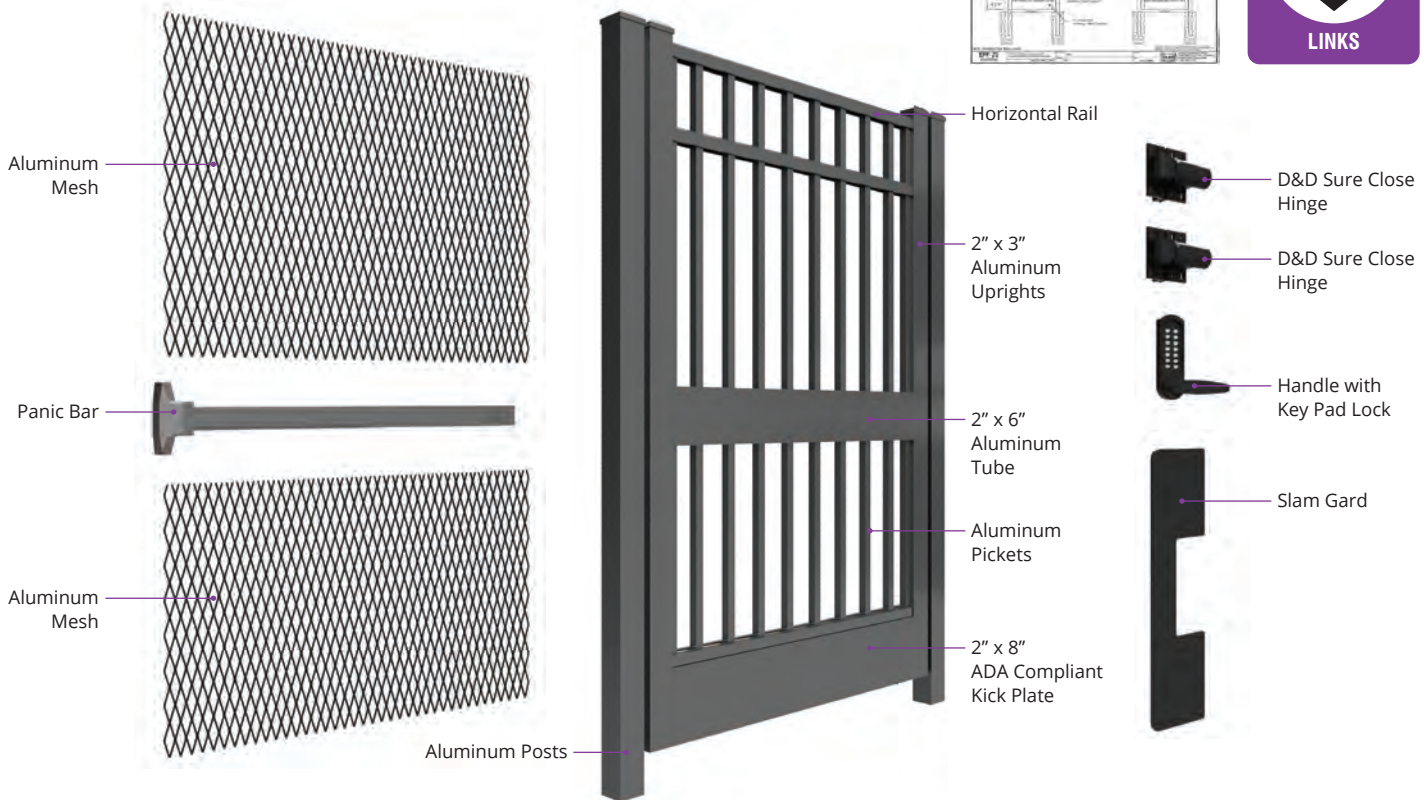

ECO-FRIENDLY



WIND/WEATHER RESISTANT



POWDER COATED
AAMA 2604-05



LOW MAINTENANCE



LIMITED LIFETIME WARRANTY



BUY AMERICAN
BE AMERICAN

ELITE
COREGard™
ARCHITECTURAL PRODUCTS

50925 Richard W. Blvd. | Chesterfield Twp., MI 48051
Phone (586) 468-4448 | Fax (586) 468-4884
1.800.783.1331 | www.EliteFence.com





42" & 48" 3-Rail Retaining Wall Fence



42" 2 or 3-Rail Commercial Patio Fence

FALLGard™ - FALL PROTECTION FENCE SYSTEMS

When FALL PROTECTION is paramount for a property, **Elite's FALLGard Perimeter Fence Systems** deliver dependable performance. Part of the **Elite COREGard Architectural Products** brand of **Elite Fence Products**, FALLGard fences are certified through rigorous physical testing to meet ICC Chapter 16 and ASCE-7 requirements. FALLGard is engineered from heavy-duty aluminum components and built for high traffic, public environments such as retaining walls and commercial patios. FALLGard fence systems provide maximum security and protection without sacrificing the view.

Designed for long-lasting performance, FALLGard fences resist rusting, warping and cracking, all without the need for painting or ongoing maintenance. FALLGard fences are powder coated to exceed AAMA 2604 standards for superior durability. FALLGard fences backed by a limited lifetime warranty.

- **Engineered for TESTED Performance.**
- **Meets or Exceeds ICC Chapter 16 and ASCE-7 Requirements**
- **3-Part Submittals Available**
- **Applications: Retaining Walls, Rooftops and Commercial/ Retail Patios**



Buy American, Be American™ 

1.800.783.1331 | www.EliteFence.com



FALLGard™ - FALL PROTECTION FENCE SYSTEMS

FALLGard Key Standards:

Fall protection railings (guardrails) must comply with local building codes like IBC/IRC for safety.

Strength: Must withstand at least 200 lbs of force applied downward or outward within 2 inches of the top edge, at any point, without failure.

Building Codes (e.g., IRC/IBC): Often for retaining walls over 30 inches high (measured from footing bottom to top of wall) to protect the public. Also consult local codes.

FALLGard Key Requirements:

ASCE 7-10 Section 4.5.1 — Handrail and Guardrail Load Requirements

ASCE 7-10, Section 4.5.1 specifies the minimum design loads for handrail and guardrail systems to ensure they can safely resist both concentrated and distributed loads.

Key Load Requirements:

- **Single Concentrated Load:** The system must be designed to resist **200 lb** applied in **any direction** at **any point** along the handrail or top rail
- **Uniform Distributed Load:** The system must also resist **50 lb/ft** applied in **any direction** along the handrail or top rail
- **In Fill and Panel Fillers:** Intermediate rails (excluding the handrail) and panel fillers must withstand a **horizontally applied normal load of 50 lb** on an area **not exceeding 12 in × 12 in** including openings and spaces between rails.

Design Intent:

- The **200 lb point load** is intended to simulate a person pushing or leaning against the rail, while the **50 lb/ft uniform load** simulates pedestrian traffic or incidental contact along the rail
- The code focuses on **strength** rather than deflection, though deflection limits may be required by other standards or local codes

In Summary: ASCE 7-10 4.5.1 requires handrail/guardrail systems to resist a 200 lb point load in any direction and a 50 lb/ft uniform load (with exemptions for certain occupancies), plus specific requirements for intermediate rails and panel fillers, all to ensure structural safety and occupant protection.

IRC Chapter 16 — RESIDENTIAL Guards and Handrails

In the **2021 International Residential Code (IRC)**, guards and handrails are defined differently:

- **Guard** — a vertical barrier to prevent accidental falls from elevated walking surfaces.
- **Handrail** — a vertical member for grasping and stability when climbing stairs or ramps

Design Loads: IRC has long required 200 lb. in any direction at any point along the top for both guards and handrails This load must be resisted in all directions, including inward, to account for potential lateral forces

Key Takeaways:

- **Load Resistance:** 200 lb. in all directions at the top of the guard or handrail.
- **Inspection:** While push/pull tests are common, the 2021 IRC's load requirements mean structural capacity must be verified to the code's design load.

FALLGard Safety Testing:

Elite uses rigorous, top-tier testing to evaluate the quality, safety, and performance of our FALLGard Fence Systems



IBC Chapter 10 — COMMERCIAL Guard and Handrail Requirements

IBC Chapter 10 (Means of Egress) sets out the code requirements for guards and handrails to prevent falls and provide guidance during vertical travel.

Guards (IBC §1015)

Guards are required along **open-sided walking surfaces** where there is a vertical drop greater than **30 inches (762 mm)** within **36 inches (914 mm)** horizontally of the open edge

- **Minimum height:** 42 in (1,067 mm) in all occupancies, measured vertically from the adjacent walking surface
- **Exceptions:** Loading docks, audience side of stages, raised platforms for entertainment, fixed-guideway transit station platforms, and similar functional openings
- **Strength:** Must comply with Section 1607.9 (typical design loads: 50 plf along top, 200 lb concentrated force)
- **Openings:** Maximum sphere opening size is 4 in (102 mm)

ADA Secondary Handrails (IBC §1014)

Handrails are required for **stairways, ramps, stepped aisles, and ramped aisles**

Height:

- Stairs: 34–38 in (864–965 mm) above the nosing of the tread
- Ramps: 34–38 in above the ramp surface

Graspability: Smooth, rounded, and free of sharp edges; must be accessible to users

Continuity: Uninterrupted along the length of the stair or ramp; intermediate handrails may be required for wide stairways

Fittings: Should prevent rotation and allow for comfortable gripping

Strength: Must comply with Section 1607.9 for structural attachment

Key Differences

- **Guards** respond to **fall exposure** (drop > 30 in within 36 in) and are vertical barriers.
- **Handrails** respond to the **presence of stairs or ramps** and are horizontal elements for guidance and support



ECO-FRIENDLY



WIND/WEATHER RESISTANT



POWDER COATED AAMA 2604-05



LOW MAINTENANCE



LIMITED LIFETIME WARRANTY



BUY AMERICAN BE AMERICAN

ELITE
COREGard™
ARCHITECTURAL PRODUCTS

50925 Richard W. Blvd. | Chesterfield Twp., MI 48051
Phone (586) 468-4448 | Fax (586) 468-4884

1.800.783.1331 | www.EliteFence.com





LIFEGard™ - PERIMETER FENCE SYSTEMS

When safety and security of a property matters most, **Elite's LIFEGard Fence Systems** deliver dependable performance. Part of the **Elite COREGard Architectural Products** brand of **Elite Fence Products**, LIFEGard fences are engineered from heavy-duty aluminum components, including rails, pickets, and posts built for demanding environments. LIFEGard fence systems provide perimeter security for pools as well as fall protection for retaining walls and embankments without sacrificing view or aesthetics.

Designed for long-lasting performance, LIFEGard fences resist rusting, warping and cracking, all without the need for painting or ongoing maintenance. LIFEGard fences are powder coated to exceed AAMA 2604 standards for superior durability. LIFEGard security fences are fully tested and backed by a limited lifetime warranty.

- **Engineered for TESTED Performance.**
- **Meets or Exceeds ASTM-BOCA Pool Fence Codes**
- **3-Part Submittals Available**
- **Applications: Commercial & Residential Pools**

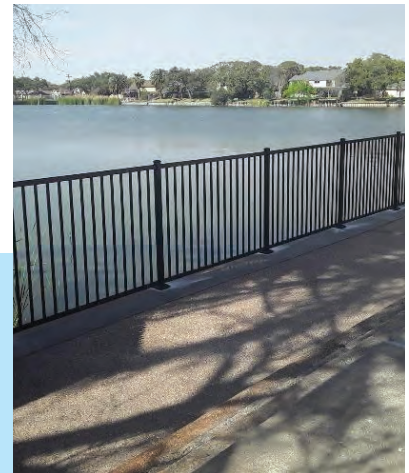

Buy American, Be American™ 

1.800.783.1331 | www.EliteFence.com













LIFEGard™ - PERIMETER FENCE SYSTEMS

LIFEGard Specs*:

Width:	6' & 7' -6 3/4"
Heights:	4'
Horz. Rails:	1-1/8" x 1-3/4"
Min. Strength:	35,000 psi
Alum. Alloy:	6005-T5 Alloy (Rails & Posts)
Posts:	2" x 2" x .080 or .125 Wall 2-1/2" x 2-1/2" x .075 Wall 2-1/2" x 2-1/2" x .100 Wall
Pickets:	3/4" x 3/4" x .050 Wall
Picket Spacing:	3-3/4" or 1-1/2"

*These are the standard specifications. Custom designs may vary.

LIFEGard Colors:

	Textured (Matte) Black		Black		Beige**
	Textured (Matte) White		White		Hartford Green**
	Textured (Matte) Quaker Bronze		Quaker Bronze		Walnut Brown**
	Textured (Matte) Sandstone		Sandstone**		

**These colors have extended lead times

Colors shown are simulated and may vary.

LIFEGard Resources:

Specifications, Drawings, Testing/Engineering, Brochure and Warranty

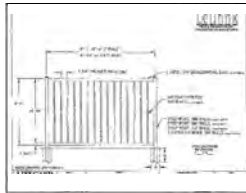

LIFEGard Profiles:

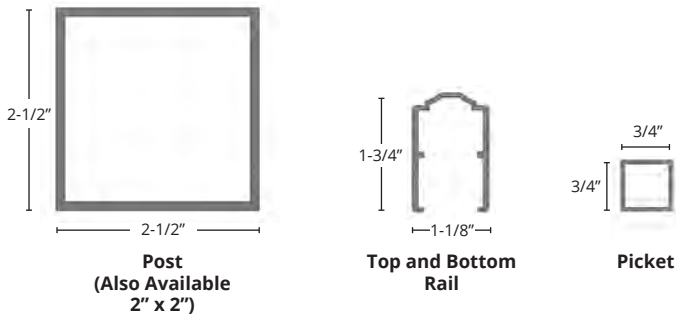

LIFEGard Components:

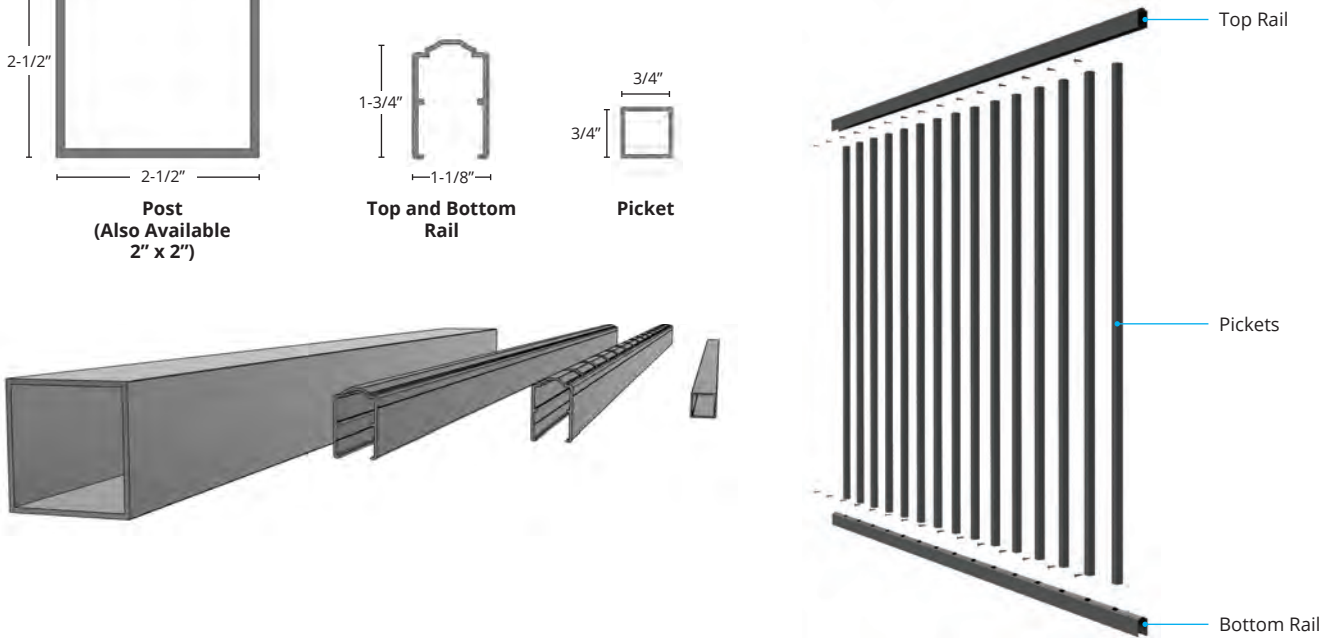

ECO-FRIENDLY



WIND/WEATHER RESISTANT



POWDER COATED
AAMA 2604-05



LOW MAINTENANCE



LIMITED LIFETIME WARRANTY



BUY AMERICAN
BE AMERICAN

ELITE
COREGard
ARCHITECTURAL PRODUCTS

50925 Richard W. Blvd. | Chesterfield Twp., MI 48051
Phone (586) 468-4448 | Fax (586) 468-4884
1.800.783.1331 | www.EliteFence.com





CORErailing™ - ASSEMBLED PANEL RAILING SYSTEMS

The **Elite CORErailing Aluminum Railing System** delivers the perfect combination of style and strength. Crafted from high-quality aluminum and powder-coated to the highest standards, it provides long-lasting durability with virtually no upkeep. It will not rust, warp, crack, or require painting, and it stands up beautifully to the elements year after year. CORErailings are powder coated to exceed AAMA 2604 standards for superior durability. The modern, post to post design complements any property. CORErailing is assembled for easy installation and cost effectiveness. All CORErailings are backed by a limited lifetime warranty.

- **Assembled Panels for Easy Installation**
- **IBC- Chapter 16/ASCE-7LIFE SAFTEY Testing**
- **Engineered for TESTED Performance**
- **3-Part Submittals Available**
- **Residential, Commercial and Multi-Family Applications**



Buy American, Be American™ 

1.800.783.1331 | www.EliteFence.com



CORErailing™ - ASSEMBLED RAILING SYSTEMS

CORErailing Specs*:

Width:	2', 4', 5' and 6'
Heights:	42" Commercial (36" Optional)
Horz. Rails:	Top - 2" w (nominal) x 1-3/4" h Bottom - 1-1/2" w x 1-1/4" h
Posts:	2", 2.5", 3.0" and 4.0" Wall with Varying Wall Thickness
Pickets:	3/4" x 3/4" x .050" Wall
Picket Spacing:	3-3/4"
Min. Strength:	35,000 psi
Alum. Alloy:	6005-T5 Alloy (Rails & Posts)

Matching Walk and Drive Gates are also available.

CORErailing Profiles:

Both Profiles are Available for Continuous Top Installation

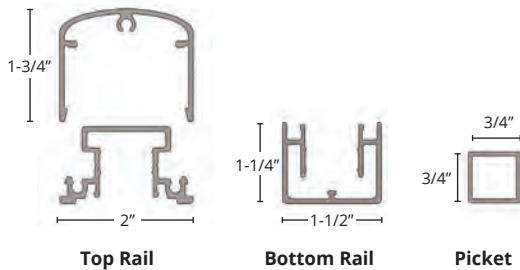

CORErailing Colors:

	Textured (Matte) Black		Black		Beige**
	Textured (Matte) White		White		Hartford Green**
	Textured (Matte) Quaker Bronze		Quaker Bronze		Walnut Brown**
	Textured (Matte) Sandstone		Sandstone**		

**These colors have extended lead times

Colors shown are simulated and may vary.

CORErailing Resources:

Specifications, Drawings, Testing/Engineering, Brochure and Warranty

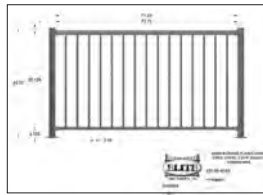

CORErailing Components:

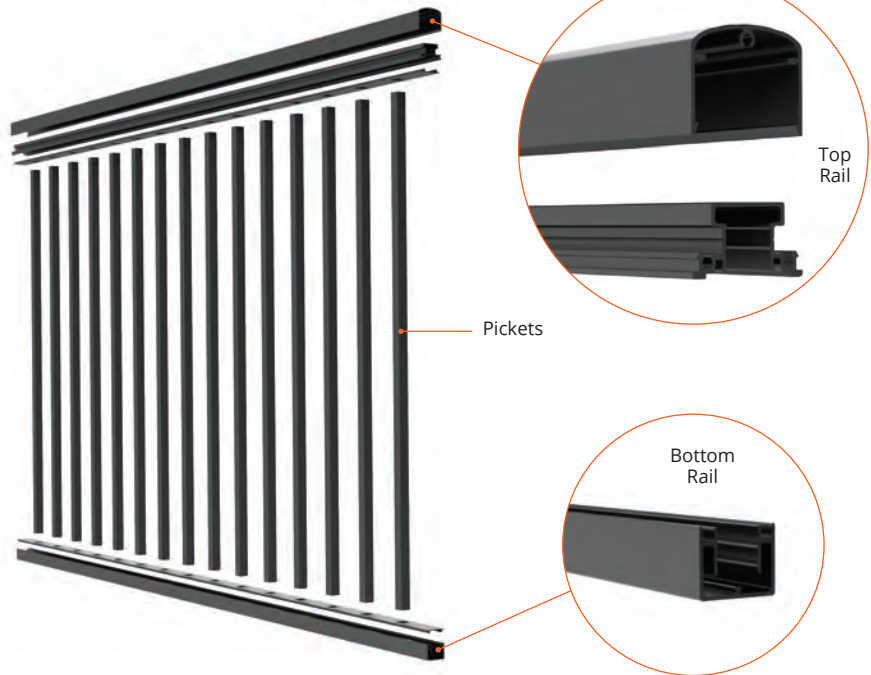

ECO-FRIENDLY



WIND/WEATHER RESISTANT



POWDER COATED
AAMA 2604-05



LOW MAINTENANCE



LIMITED LIFETIME WARRANTY



BUY AMERICAN
BE AMERICAN

ELITE
COREGard
ARCHITECTURAL PRODUCTS

50925 Richard W. Blvd. | Chesterfield Twp., MI 48051
Phone (586) 468-4448 | Fax (586) 468-4884
1.800.783.1331 | www.EliteFence.com





LEGACY 158 - ALUMINUM RAILING SYSTEMS

The **Elite LEGACY Aluminum 1-5/8" Railing System** delivers the perfect combination of style and strength. Crafted from high-quality aluminum and powder-coated to the highest standards, it provides long-lasting durability with virtually no upkeep. It will not rust, warp, crack, or require painting, and it stands up beautifully to the outdoor elements. The clean, modern design complements any property. The panels are pre-assembled, making installation easy and cost-effective. LEGACY railing systems are backed by a limited lifetime warranty.

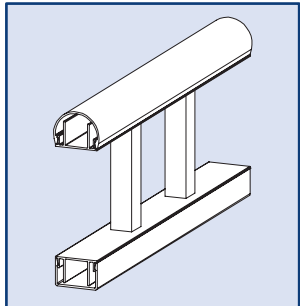

1-5/8" Round Top
1-5/8" x 1-1/4"

LEGACY 1-5/8" Round Top Styles:

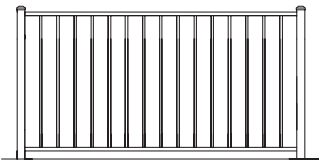

EFR-20 2-Rail

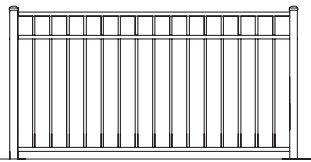

EFR-20 3-Rail

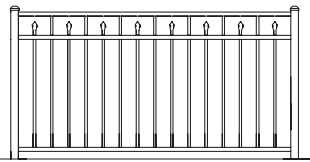

EFR-25

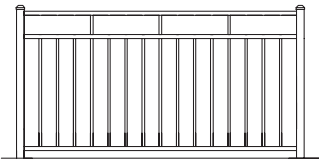

EFR-40

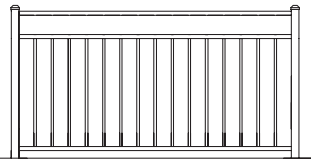

EFR-50
(Maximum 5' Width)

Available in Post to Post or Continuous

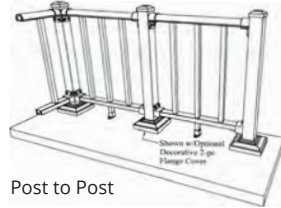

Post to Post

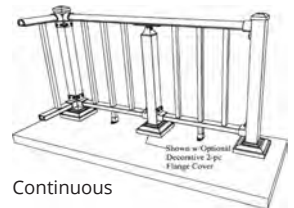

Continuous



Buy American, Be American™ 

1.800.783.1331 | www.EliteFence.com













LEGACY 158 - ALUMINUM RAILING SYSTEMS

LEGACY 1-5/8" Specs:

Width:	2', 4' and 6' Panels
Heights:	3' (36") and 3-1/2' (42")
Top Rail:	1-5/8" x 1-1/4"
Bottom Rail:	1-1/2" x 1"
Posts:	2" x 2" x .125 Wall Only 2-1/2" x 2-1/2" x .100 Wall 3" x 3" x .125 Wall 4" x 4" x .125/.250 Wall 6" x 6" x .125/.250 Wall
Pickets:	3/4" x 3/4" x .050 Wall 3/4" Round .065 Wall
Picket Spacing:	3-3/4"
Min. Strength:	35,000 psi
Alum. Alloy:	6005-T5 Alloy (Rails & Posts)

Matching Walk and Drive Gates are also available.

LEGACY Colors:

	Textured (Matte) Black		Black		Beige**
	Textured (Matte) White		White		Hartford Green**
	Textured (Matte) Quaker Bronze		Quaker Bronze		Walnut Brown**
	Textured (Matte) Sandstone		Sandstone**		

**These colors have extended lead times

Colors shown are simulated and may vary.

LEGACY Resources:

Specifications, Drawings, Testing/Engineering, Brochure and Warranty

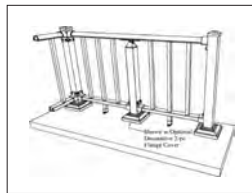

LEGACY 1-5/8" Profiles:

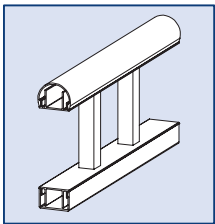

1-5/8" Round Top
1-5/8" x 1-1/4"

Available Post to Post and Continuous Top Cover

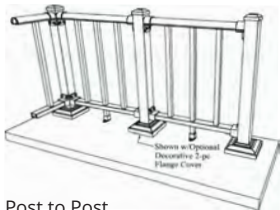

Post to Post

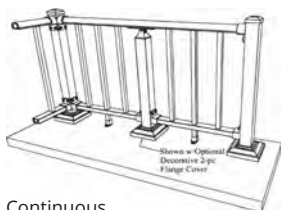

Continuous

LEGACY 1-5/8" Components:

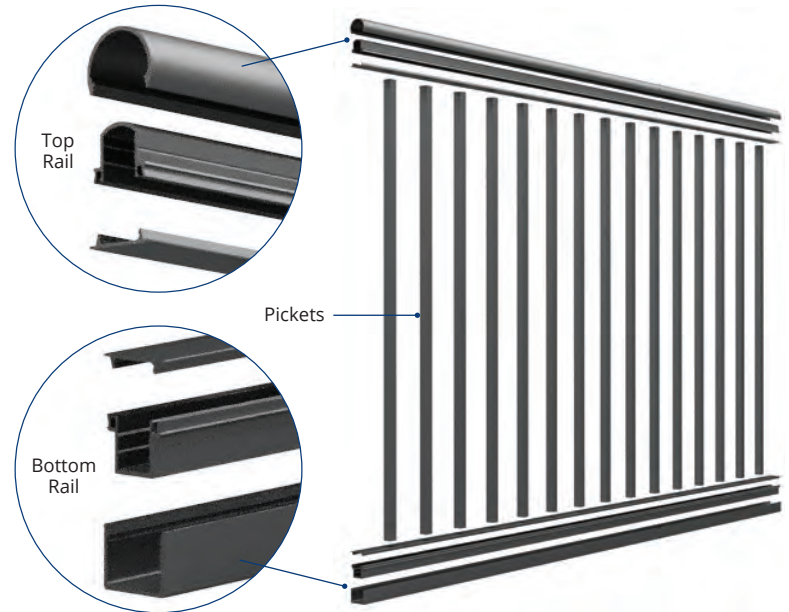

ECO-FRIENDLY



WIND/WEATHER
RESISTANT



POWDER COATED
AAMA 2604-05



LOW
MAINTENANCE



LIMITED LIFETIME
WARRANTY



BUY AMERICAN
BE AMERICAN

ELITE
COREGard
ARCHITECTURAL PRODUCTS

50925 Richard W. Blvd. | Chesterfield Twp., MI 48051
Phone (586) 468-4448 | Fax (586) 468-4884
1.800.783.1331 | www.EliteFence.com





LEGACY 250 - ALUMINUM RAILING SYSTEMS

The **Elite LEGACY Aluminum 2-1/2" Railing System** delivers the perfect combination of style and strength. Crafted from high-quality aluminum and powder-coated to the highest standards, it provides long-lasting durability with virtually no upkeep. It will not rust, warp, crack, or require painting, and it stands up beautifully to the outdoor elements. The clean, modern design complements any property. The panels are pre-assembled, making installation easy and cost-effective. LEGACY railing systems are backed by a limited lifetime warranty.

LEGACY 2-1/2" Top Styles:

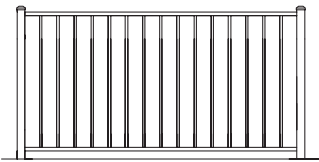

EFR-20 2-Rail

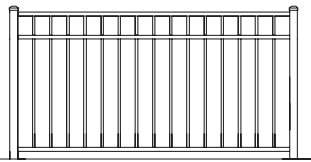

EFR-20 3-Rail

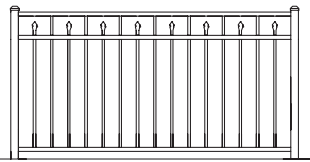

EFR-25

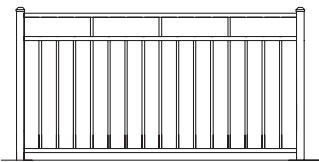

EFR-40

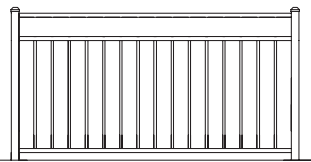

EFR-50
(Maximum 5' Width)

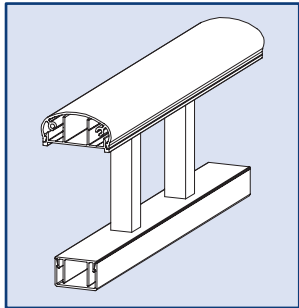

2-1/2" Top Cover
2-1/2" x 1-1/4"

Available in Post to Post or Continuous

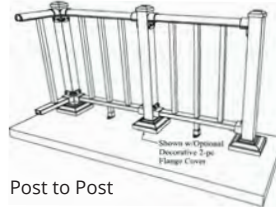

Post to Post

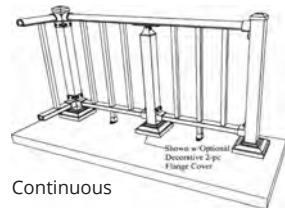

Continuous



Buy American, Be American™ 

1.800.783.1331 | www.EliteFence.com



LEGACY 250 - ALUMINUM RAILING SYSTEMS

LEGACY 2-1/2" Specs:

Width:	2', 4' and 6' Panels
Heights:	3' (36") and 3-1/2' (42")
Top Rail:	2-1/2" x 1-1/4"
Bottom Rail:	1-1/2" x 1"
Posts:	2" x 2" x .125 Wall Only 2-1/2" x 2-1/2" x .100 Wall 3" x 3" x .125 Wall 4" x 4" x .125/.250 Wall 6" x 6" x .125/.250 Wall
Pickets:	3/4" x 3/4" x .050 Wall 3/4" Round .065 Wall
Picket Spacing:	3-3/4"
Min. Strength:	35,000 psi
Alum. Alloy:	6005-T5 Alloy (Rails & Posts)

Matching Walk and Drive Gates are also available.

LEGACY 2-1/2" Profiles:

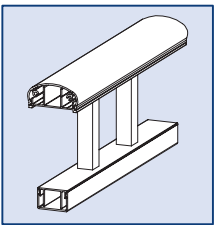

2-1/2" Top Cover
2-1/2" x 1-1/4"

Available Post to Post and Continuous Top Cover

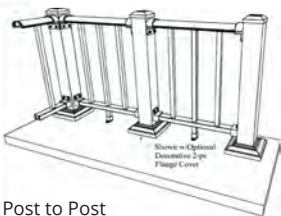

Post to Post

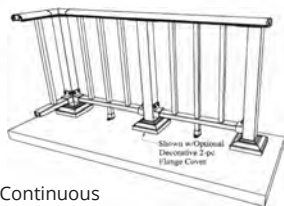

Continuous

LEGACY Colors:

	Textured (Matte) Black		Black		Beige**
	Textured (Matte) White		White		Hartford Green**
	Textured (Matte) Quaker Bronze		Quaker Bronze		Walnut Brown**
	Textured (Matte) Sandstone		Sandstone**	Colors shown are simulated and may vary.	

**These colors have extended lead times

LEGACY Resources:

Specifications, Drawings, Testing/Engineering, Brochure and Warranty

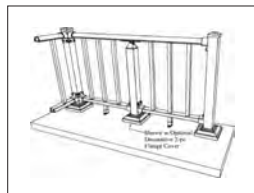

LEGACY 2-1/2" Components:

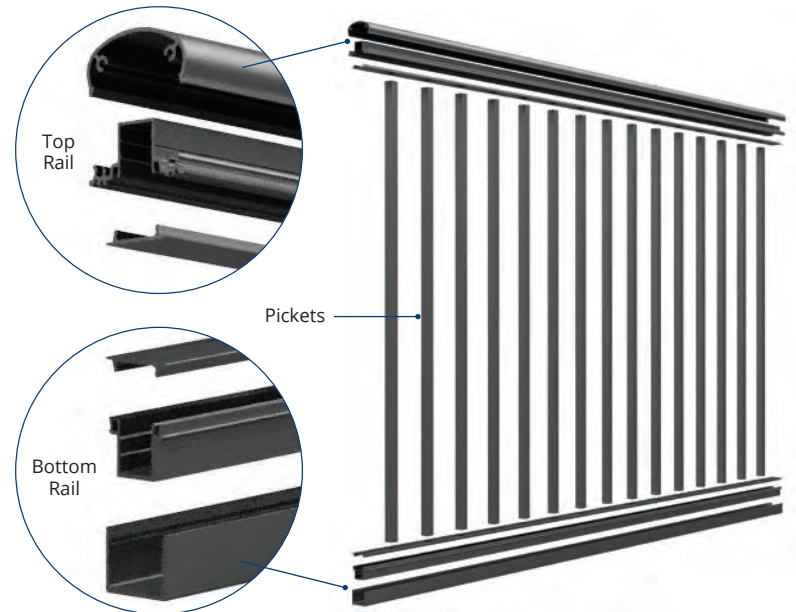

ECO-FRIENDLY



WIND/WEATHER RESISTANT



POWDER COATED
AAMA 2604-05



LOW MAINTENANCE



LIMITED LIFETIME WARRANTY



BUY AMERICAN
BE AMERICAN

ELITE
COREGard
ARCHITECTURAL PRODUCTS

50925 Richard W. Blvd. | Chesterfield Twp., MI 48051
Phone (586) 468-4448 | Fax (586) 468-4884
1.800.783.1331 | www.EliteFence.com





PRIVACYGard™ ALUMINUM - T&G 2x3 and 2x6 Vertical and Horizontal

When privacy matters, choose **Elite PRIVACYGard Systems**, part of the **Elite COREGard Architectural Products** brand of **Elite Fence Products**. Our **ALUMINUM** privacy solutions are built from premium aluminum with a minimum strength of 35,000 psi and powder coated to meet the highest AAMA 2604 standards. Designed for lasting performance, they resist rusting, warping and cracking, all without the need for painting or constant upkeep. With clean, modern lines that enhance any property and simple installation, Elite PRIVACYGard delivers both style and strength. Our aluminum PRIVACYGard Fences are tested and engineered using plated and in-ground posts, to ensure high-performance and reliability.

- **Vertical and Horizontal Styles**
- **Hidden Fasteners Provide a Clean Look**
- **Project-specific Stamped Engineering Drawings Available Upon Request. (Fees May Apply)**
- **3-Part Submittals Available**
- **Uses Include: Pool Fences, Shared Balcony Dividers, Restaurants, Hiding Machinery, Concealing Dumpsters**



Buy American, Be American™ 

1.800.783.1331 | www.EliteFence.com



PRIVACYGard™ ALUMINUM

T&G 2x3 and 2x6 Vertical and Horizontal

PRIVACYGard Specs*:

Widths:	6' Horizontal and Vertical
Heights:	4', 5', 6', 7' and 8'
Min. Strength:	35,000 psi
Alum. Alloy:	6005-T5 Alloy
Posts:	3", 4" and 6"

Matching Walk and Drive Gates are also available.

*These are the standard specifications. Custom designs may vary.

PRIVACYGard Colors:

	Textured (Matte) Black***		Black		Beige**
	Textured (Matte) White***		White		Hartford Green**
	Textured (Matte) Quaker Bronze***		Quaker Bronze		Walnut Brown**
	Textured (Matte) Sandstone***		Sandstone**	Colors shown are simulated and may vary.	

**These colors have extended lead times.

***Preferred colors for PrivacyGard products.

PRIVACYGard Profiles:

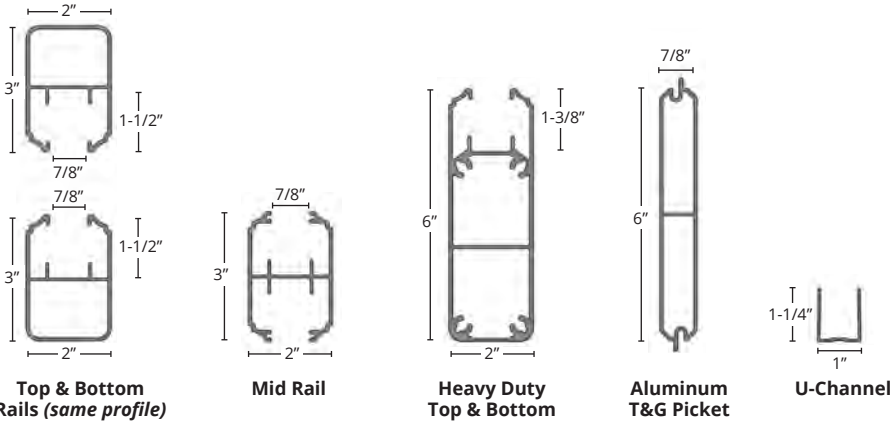

PRIVACYGard Resources:

Specifications, Drawings, Testing/Engineering, Brochure and Warranty

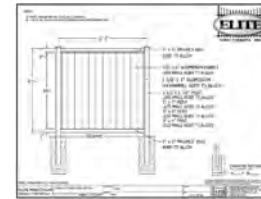

PRIVACYGard Components:

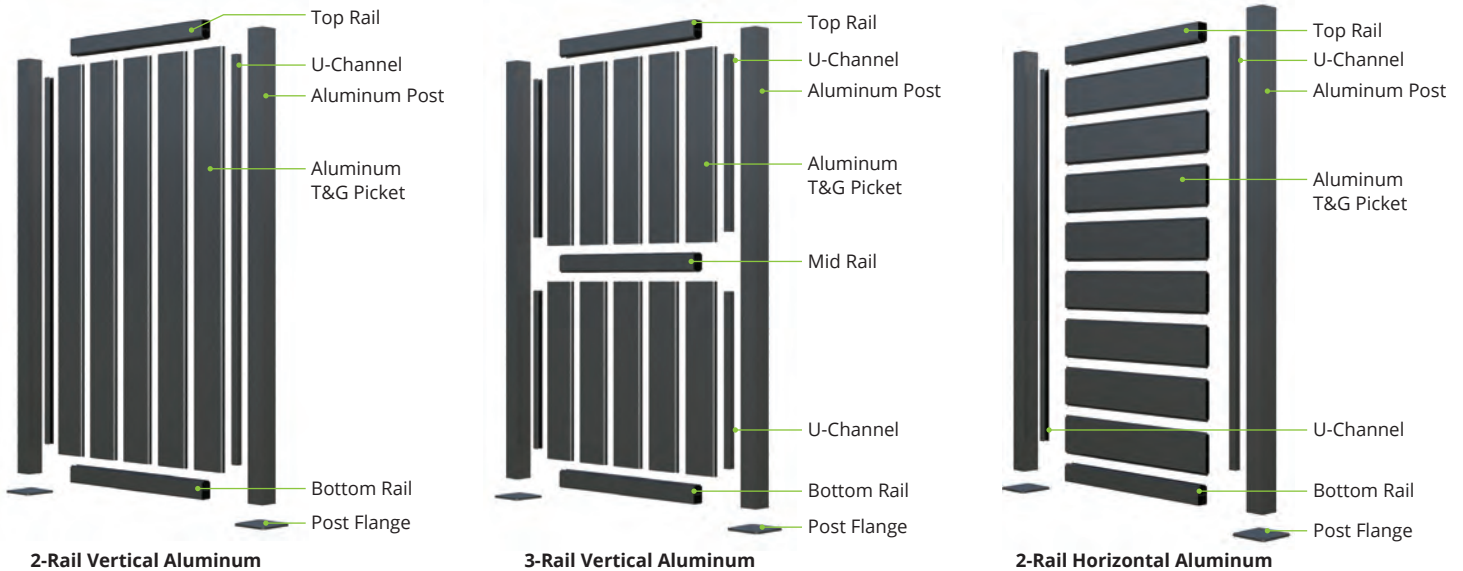

ECO-FRIENDLY



WIND/WEATHER RESISTANT



POWDER COATED AAMA 2604-05



LOW MAINTENANCE



LIMITED LIFETIME WARRANTY



BUY AMERICAN BE AMERICAN

ELITE
COREGard™
ARCHITECTURAL PRODUCTS

50925 Richard W. Blvd. | Chesterfield Twp., MI 48051
Phone (586) 468-4448 | Fax (586) 468-4884
1.800.783.1331 | www.EliteFence.com





PRIVACYGard™ H.A.S.P. - Horizontal Aluminum Semi Privacy

When privacy matters, choose **Elite PRIVACYGard Systems**, part of the **Elite COREGard Architectural Products** brand of **Elite Fence Products**. Our **H.A.S.P. (Horizontal Aluminum Semi Privacy)** fences are designed to create separation without feeling closed in. They are the perfect balance of privacy, airflow, and a clean, modern style. H.A.S.P. fences are built from premium aluminum with a minimum strength of 35,000 psi and powder coated to meet the highest AAMA 2604 standards. Our aluminum PRIVACYGard Fences are tested and engineered using plated and in-ground posts, to ensure high-performance and reliability.

- **Semi Private Design Allows Airflow and Filtered Light**
- **Hidden Fasteners Provide a Clean Look**
- **Project-specific Stamped Engineering Drawings Available Upon Request. (Fees May Apply)**
- **3-Part Submittals Available**
- **Uses Include: Pool Fences, Shared Balcony Dividers, Restaurants, Hiding Machinery, Concealing Dumpsters**



Buy American, Be American™ 

1.800.783.1331 | www.EliteFence.com



PRIVACYGard™ H.A.S.P.

Horizontal Aluminum Semi Privacy

PRIVACYGard H.A.S.P. Specs*:

Widths:	6' and 8' Horizontal
Heights:	3', 4', 5', 6', 7' and 8'
Min. Strength:	35,000 psi
Alum. Alloy:	6005-T5 Alloy
Posts:	3", 4" and 6"

Matching Walk and Drive Gates are also available.

*These are the standard specifications. Custom designs may vary.

PRIVACYGard H.A.S.P. Profiles:

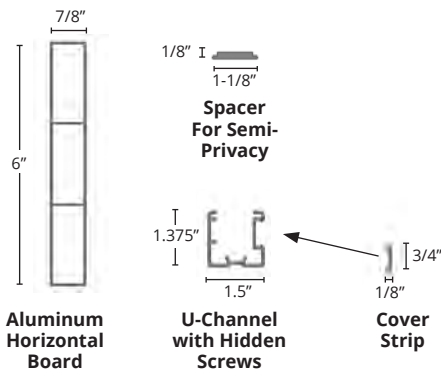

PRIVACYGard H.A.S.P. Colors:

	Textured (Matte) Black***		Black		Beige**
	Textured (Matte) White***		White		Hartford Green**
	Textured (Matte) Quaker Bronze**		Quaker Bronze		Walnut Brown**
	Textured (Matte) Sandstone**		Sandstone**	Colors shown are simulated and may vary.	

**These colors have extended lead times.

***Preferred colors for PrivacyGard products.

PRIVACYGard H.A.S.P. Resources:

Specifications, Drawings, Testing/Engineering, Brochure and Warranty

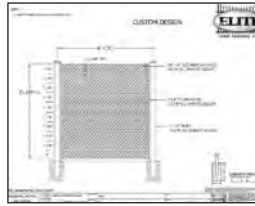

PRIVACYGard H.A.S.P. Components:

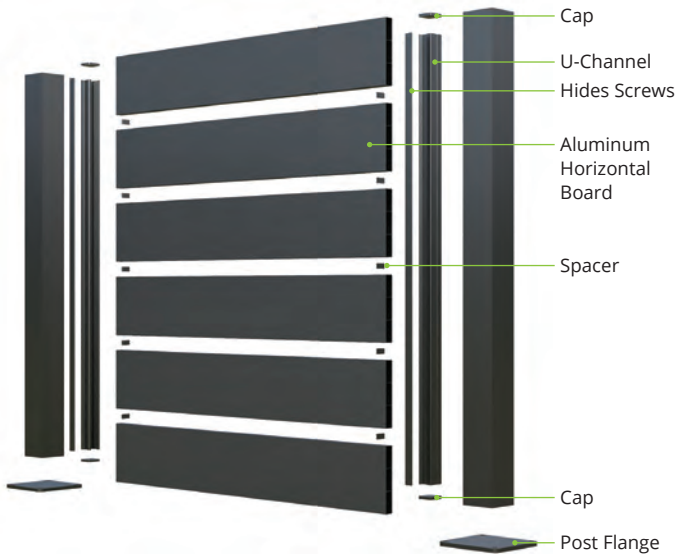

ECO-FRIENDLY



WIND/WEATHER RESISTANT



POWDER COATED AAMA 2604-05



LOW MAINTENANCE



LIMITED LIFETIME WARRANTY



BUY AMERICAN BE AMERICAN

ELITE
COREGard™
ARCHITECTURAL PRODUCTS

50925 Richard W. Blvd. | Chesterfield Twp., MI 48051
Phone (586) 468-4448 | Fax (586) 468-4884

1.800.783.1331 | www.EliteFence.com





PRIVACYGard™ HYBRID

Aluminum and Vinyl Privacy Fence

When privacy matters, choose **Elite PRIVACYGard Systems**, part of the **Elite COREGard Architectural Products** brand of **Elite Fence Products**. Our **HYBRID** privacy solutions are built with a premium aluminum frame and colorful, fade-resistant vinyl boards. These low-maintenance hybrid fences deliver virtually endless color combinations to enhance your outdoor living space. Designed for lasting performance, our aluminum features a minimum strength of 35,000 psi and is powder coated to meet the highest AAMA 2604 standards. Hybrid PRIVACYGard fences are tested and engineered using plated and in-ground posts, to ensure high-performance and reliability.

- **Variegated Vinyl has a Non-Repeating Woodgrain Pattern**
- **Perfect Way to Add Lasting Color to Your Property**
- **Offers FIELD FLEXability with All Based on 7/8"**
- **Project-specific Stamped Engineering Drawings Available Upon Request. (Fees May Apply)**
- **3-Part Submittals Available**
- **Uses Include: Pool Fences and Shared Balcony Dividers**



Buy American, Be American™ 

1.800.783.1331 | www.EliteFence.com



PRIVACYGard™ HYBRID

Aluminum and Vinyl Privacy Fence

PRIVACYGard Hybrid Specs*:

- Widths: 6' and 8' Vertical
6' Only for Horizontal
- Heights: 4', 5', 6', 7' and 8'
- Min. Strength: 35,000 psi
- Alum. Alloy: 6005-T5 Alloy
- Posts: 3", 4" and 6"

Matching Walk and Drive Gates are also available.
*These are the standard specifications. Custom designs may vary.

PRIVACYGard Hybrid Profiles:

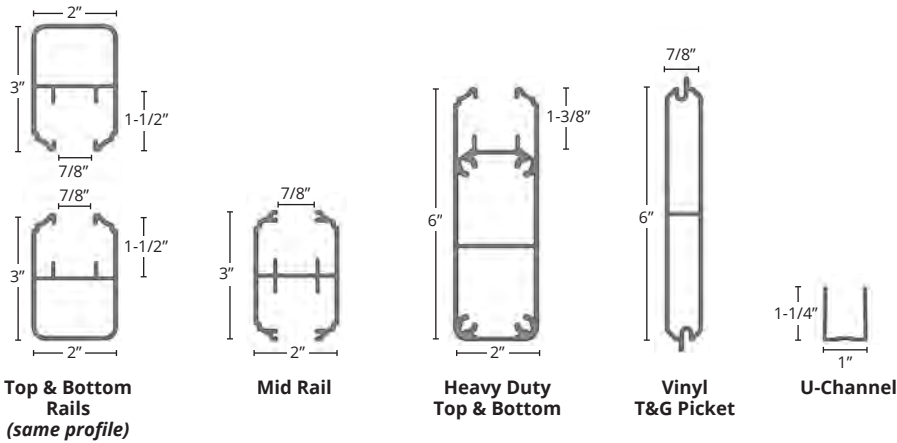

PRIVACYGard Aluminum Colors:

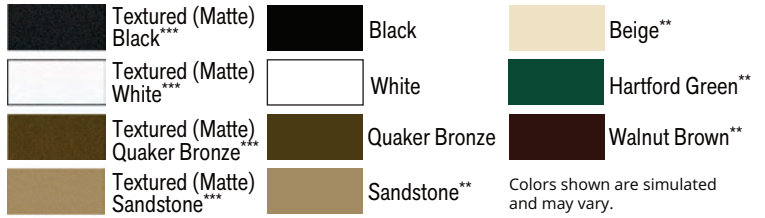

**These colors have extended lead times.
***Preferred colors for PrivacyGard products.

PRIVACYGard Vinyl Colors:



*Colors shown are simulated and may vary.

PRIVACYGard Hybrid Components:

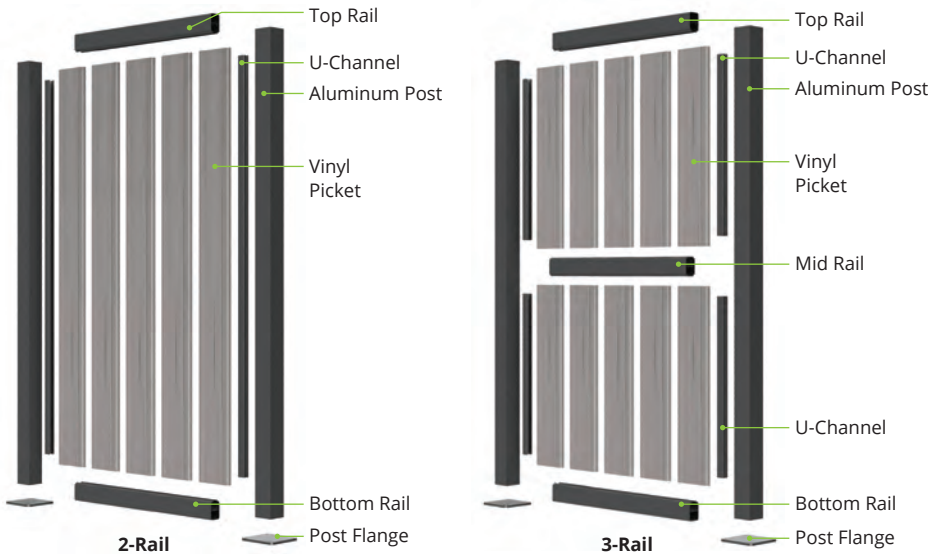

PRIVACYGard Hybrid Resources:

Specifications, Drawings, Testing/Engineering, Brochure and Warranty

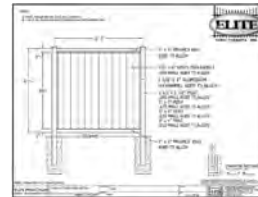

ECO-FRIENDLY



WIND/WEATHER RESISTANT



POWDER COATED AAMA 2604-05



LOW MAINTENANCE



LIMITED LIFETIME WARRANTY



BUY AMERICAN BE AMERICAN

ELITE
COREGard™
ARCHITECTURAL PRODUCTS

50925 Richard W. Blvd. | Chesterfield Twp., MI 48051
Phone (586) 468-4448 | Fax (586) 468-4884
1.800.783.1331 | www.EliteFence.com





PRIVACYGard™ LOUVERED

Aluminum Privacy Fence, Gates and Enclosures

When privacy matters, choose **Elite PRIVACYGard Systems**, part of the **Elite COREGard Architectural Products** brand of **Elite Fence Products**. Our **LOUVERED** privacy solutions are built from premium aluminum with a minimum strength of 35,000 psi and powder coated to meet the highest AAMA 2604 standards. Our louvered systems provide full visual screening without sacrificing ventilation. The precision-angled louvers deflect direct views while promoting airflow, making it a smart solution for commercial and industrial applications. Designed for lasting performance, they resist rusting, warping and cracking, all without the need for painting or constant upkeep. Our aluminum PRIVACYGard Fences are tested and engineered using plated and in-ground posts, to ensure high-performance and reliability.

- Provides Security & Durability While Concealing Unsightly Areas
- Elite's Extensive Line of AXIS Hinges Provide Exact Color Matching
- Project-specific Stamped Engineering Drawings Available Upon Request. (Fees May Apply)
- 3-Part Submittals Available
- Uses Include: Hiding Machinery, Concealing Dumpsters



Buy American, Be American™ 

1.800.783.1331 | www.EliteFence.com



PRIVACYGard™ LOUVERED

Aluminum Privacy Fence, Gates and Enclosures











PRIVACYGard Louvered Specs*:

Widths:	1' - 8' Vertical
Heights:	3' - 10'
Min. Strength:	35,000 psi
Alum. Alloy:	6005-T5 Alloy
Posts:	4" and 6"

Matching Walk and Drive Gates are also available.

*These are the standard specifications. Custom designs may vary.

PRIVACYGard Louvered Colors:

	Textured (Matte) Black***		Black		Beige**
	Textured (Matte) White***		White		Hartford Green**
	Textured (Matte) Quaker Bronze**		Quaker Bronze		Walnut Brown**
	Textured (Matte) Sandstone***		Sandstone**	Colors shown are simulated and may vary.	

**These colors have extended lead times.
***Preferred colors for PrivacyGard products.

PRIVACYGard Louvered Profiles:

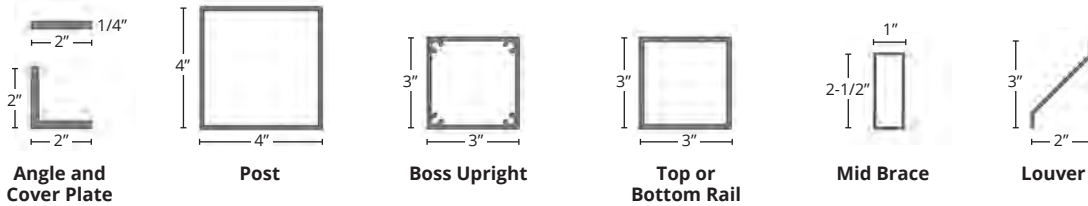

PRIVACYGard Louvered Components:

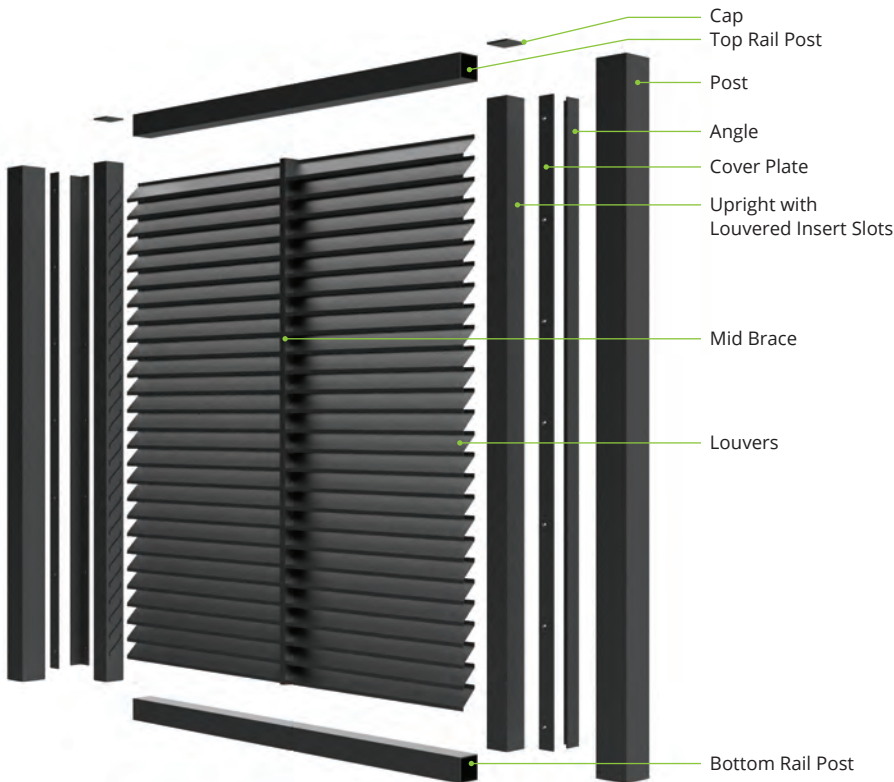

PRIVACYGard Louvered Resources:

Specifications, Drawings, Testing/Engineering, Brochure and Warranty

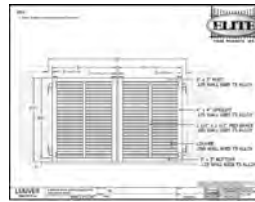

ECO-FRIENDLY



WIND/WEATHER RESISTANT



POWDER COATED AAMA 2604-05



LOW MAINTENANCE



LIMITED LIFETIME WARRANTY



BUY AMERICAN BE AMERICAN

ELITE
COREGard™
ARCHITECTURAL PRODUCTS

50925 Richard W. Blvd. | Chesterfield Twp., MI 48051
Phone (586) 468-4448 | Fax (586) 468-4884
1.800.783.1331 | www.EliteFence.com





PRIVACYGard™ Dumpster Surrounds

Aluminum T&G and Louvered Styles

Elite Dumpster Surrounds are designed to enhance a property's appearance while keeping waste areas clean, secure, and out of sight. **Elite PRIVACYGard Dumpster Surrounds**, part of the **Elite COREGard Architectural Products** brand of **Elite Fence Products**, help maintain a polished look and prevent public access — an ideal solution for retail centers, commercial properties and multi-family communities where on-site trash storage is essential.

Our Dumpster Surrounds can be designed using our PRIVACYGard Louvered panels or our Aluminum T&G panels. These enclosures effectively conceal contents while still allowing for proper ventilation. Our surrounds are built from premium aluminum with a minimum strength of 35,000 psi and powder coated to meet the highest AAMA 2604 standards. Whether you're securing dumpsters, equipment or service areas, Elite's Axis heavy-duty hinges and gate latches provide dependable security with smooth, easy operation. Elite's PRIVACYGard Dumpster Surrounds are tested and engineered for strength, using both plated and in-ground post options to ensure professional-grade construction.

- Provides Security & Durability While Concealing Waste Areas
- Low Maintenance - Resists Rust, Warping and Cracking
- Elite's Vast Line of AXIS Hinges Provide Exact Color Matching
- Engineered & Tested for Performance
- 3-Part Submittals Available

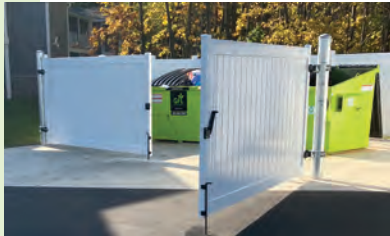

Buy American, Be American™ 

1.800.783.1331 | www.EliteFence.com



PRIVACYGard™ Dumpster Surrounds

Aluminum T&G and Louvered Styles

PRIVACYGard Dumpster Surround Specs*:

Widths:	6' and 8' Vertical
Heights:	4', 5' and 6'
Min. Strength:	35,000 psi
Alum. Alloy:	6005-T5 Alloy
Posts:	3" and 4", 0.125 Wall

*All are Custom designs, so specs will vary.

PRIVACYGard Dumpster Surround Resources:

Specifications, Drawings, Testing/Engineering, Brochure and Warranty

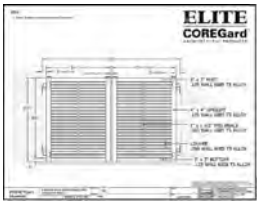

PRIVACYGard Colors:

	Textured (Matte) Black***		Black		Beige**
	Textured (Matte) White***		White		Hartford Green**
	Textured (Matte) Quaker Bronze**		Quaker Bronze		Walnut Brown**
	Textured (Matte) Sandstone***		Sandstone**	Colors shown are simulated and may vary.	

**These colors have extended lead times.

***Preferred colors for PrivacyGard products.

PRIVACYGard Dumpster Surround Components:

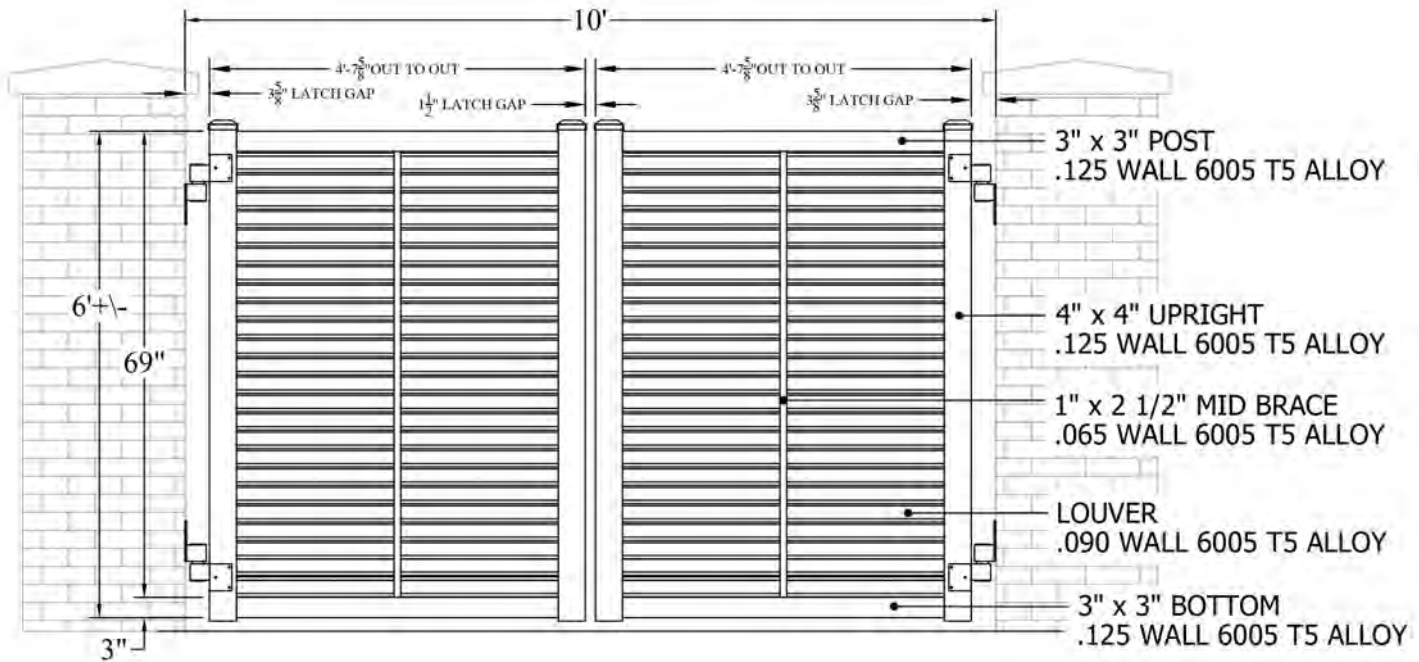

ECO-FRIENDLY



WIND/WEATHER RESISTANT



POWDER COATED
AAMA 2604-05



LOW MAINTENANCE



LIMITED LIFETIME WARRANTY



BUY AMERICAN
BE AMERICAN

ELITE
COREGard™
ARCHITECTURAL PRODUCTS

50925 Richard W. Blvd. | Chesterfield Twp., MI 48051
Phone (586) 468-4448 | Fax (586) 468-4884
1.800.783.1331 | www.EliteFence.com





Meets OSHA Requirements
1926.502(b)(3) and (b)(4), 1910.29(b)(3) and (b)(4)
for Permanent Fall Protection

SAFETYGard™ RAILING SYSTEMS

The **Elite SAFETYGard Railing Systems** deliver the perfect combination of security and strength. The **Elite SAFETYGard Railings** are part of the **Elite COREGard Architectural Products** a brand of **Elite Fence Products**. Crafted from high-quality aluminum and powder-coated to the highest AAMA 2604 standards, it provides long-lasting durability with virtually no upkeep. It will not rust, warp, crack, or require painting, and it stands up beautifully to the elements year after year. Its clean, modern design complements any property, while easy installation makes it a smart choice.



Every railing system is engineered and fully tested to meet local building codes. Third party testing and evaluation reports are available. Elite's SAFETYGard Railing Systems are backed by a limited lifetime warranty.



- **Tested to Meet or Exceed OSHA & ANSI Standards**
- **Engineered & Tested for Performance**
- **3-Part Submittals Available**
- **Heavy-Duty Aluminum Railing with Stanchion Post Mounts**
- **Commercial and Industrial Applications**



Buy American, Be American™ 

1.800.783.1331 | www.EliteFence.com













SAFETYGard™ RAILING SYSTEMS

SAFETYGard Specs*:

Heights:	3' and 3 1/2'
Min. Strength:	35,000 psi
Alum. Alloy:	6005-T5 Alloy (Rails & Posts)
Posts:	3" x 3" x .125 Wall 4" x 4" x .125/.250 Wall
Hor. Rails:	1-1/4" x 1-1/2" with a 1" x 1" Internal Picket

*Custom designs may vary.

SAFETYGard Colors:

	Textured (Matte) Black		Black		Beige**
	Textured (Matte) White		White		Hartford Green**
	Textured (Matte) Quaker Bronze		Quaker Bronze		Walnut Brown**
	Textured (Matte) Sandstone		Sandstone**	Colors shown are simulated and may vary.	

**These colors have extended lead times

SAFETYGard Resources:

Specifications, Drawings, Testing/Engineering, Brochure and Warranty

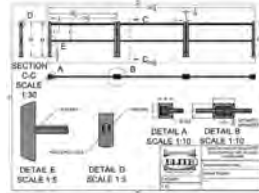

SAFETYGard Profiles:

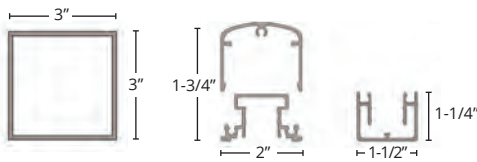

Routed Post

Horizontal Rail

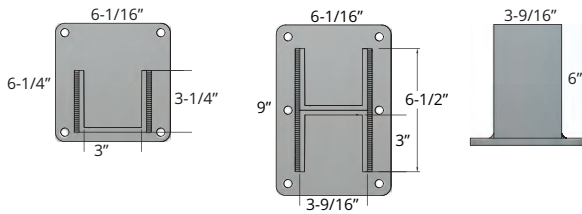

Stanchion Mounts

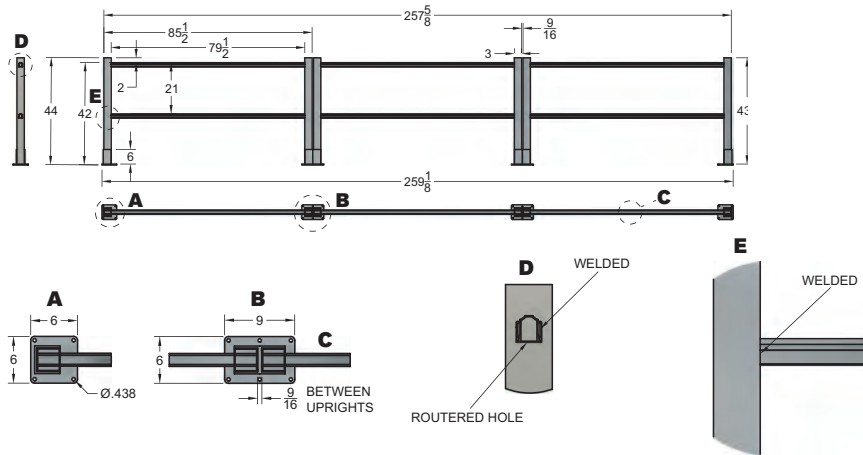

SAFETYGard Components:



ECO-FRIENDLY



WIND/WEATHER RESISTANT



POWDER COATED
AAMA 2604-05



LOW MAINTENANCE



LIMITED LIFETIME WARRANTY



BUY AMERICAN
BE AMERICAN

ELITE
COREGard™
ARCHITECTURAL PRODUCTS

50925 Richard W. Blvd. | Chesterfield Twp., MI 48051
Phone (586) 468-4448 | Fax (586) 468-4884
1.800.783.1331 | www.EliteFence.com



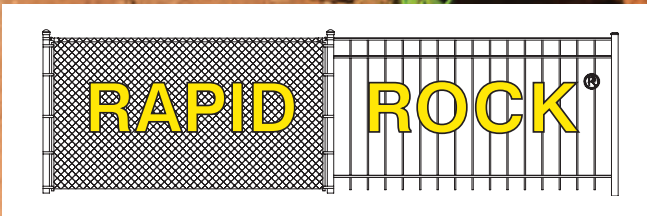

THE FENCER'S CHOICE!

The 10 Minute Fence Setting, Anchoring Cement!

Rapid Rock® is a fast-setting, high-strength anchoring cement that will not shrink. Rapid Rock can be used to set fence and gate posts in ground or in existing concrete slabs. Rapid Rock can be used "neat" (right out of the pail) or it can be mixed with a regular concrete mix to accelerate the setting time of Portland cement based concrete mixes. Set times will vary when Rapid Rock is mixed with a portland cement based concrete mix.

FEATURES & BENEFITS:

- Pre-mixed, Ready to Use
- Sets Fence Post, Handrails and Anchor Bolts
- Non Shrink with Exceptional Bond Strength
- Not Affected by Continual Exposure to Water
- May be Placed at Temperatures Down to 20°F (-7°C) *if ACI 306 Cold Weather Concreting Standards are Followed*
- Resists Freeze -Thaw Cycles and Deicing Chemicals
- Easy Open, Resealable Lid
- Saves Time and Money
- For Fence Posts, Decks, Mailboxes, Flag Poles

Keep out of the reach of children. For professional use only. See back panel of pail for directions for safe use of this product.

Rapid Rock is Distributed by Elite Fence Products, Inc.



SPECS:

Pail Weight: 50 Lbs
Dimensions: 15"h x 12"w
UPC Code: 0 31187 01450

DIRECTIONS:

It is recommended that when setting fence posts, you mix Rapid Rock® with a portland cement based concrete mix. You should mix one part Rapid Rock® to 10 parts concrete mix. Add only enough water to make a plastic like consistency. DO NOT add too much water. Adding too much water will effect the setting time of Rapid Rock® and may effect the strength of the concrete/Rapid Rock mix. Mix only as much material as you can use in 5 minutes. After the mix has set, you CANNOT use more water to re temper the mix. You will have to mix a new batch. Make sure the post hole is adequate to support the fence. The hole should be 5 times the diameter of the post.



Buy American, Be American™

50925 Richard W. Blvd. | Chesterfield Twp., MI 48051
Phone (586) 468-4448 | Fax (586) 468-4884

1.800.783.1331 | www.EliteFence.com

