

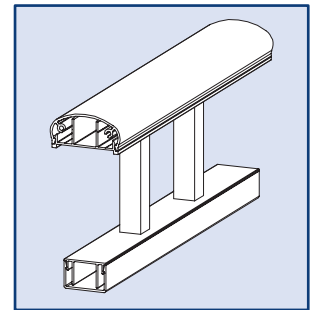

LEGACY 250 - ALUMINUM RAILING SYSTEMS

The **Elite LEGACY Aluminum 2-1/2" Railing System** delivers the perfect combination of style and strength. Crafted from high-quality aluminum and powder-coated to the highest standards, it provides long-lasting durability with virtually no upkeep. It will not rust, warp, crack, or require painting, and it stands up beautifully to the outdoor elements. The clean, modern design complements any property. The panels are pre-assembled, making installation easy and cost-effective. LEGACY railing systems are backed by a limited lifetime warranty.



2-1/2" Top Cover
 2-1/2" x 1-1/4"

LEGACY 2-1/2" Top Styles:

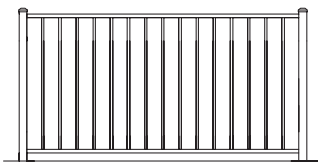

EFR-20 2-Rail

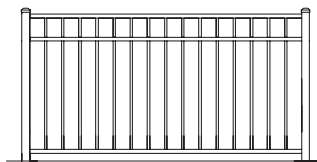

EFR-20 3-Rail

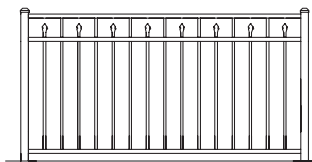

EFR-25

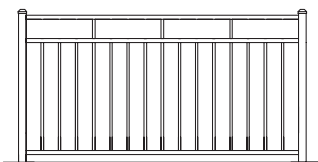

EFR-40

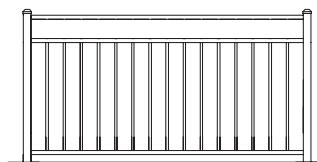

EFR-50
 (Maximum 5' Width)

Available in Post to Post or Continuous

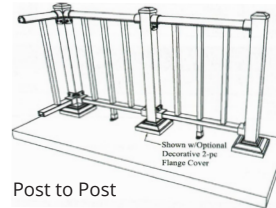

Post to Post

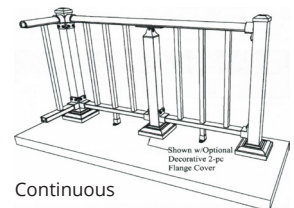

Continuous



Buy American, Be American™



1.800.783.1331

www.EliteFence.com



LEGACY 250 - ALUMINUM RAILING SYSTEMS

LEGACY 2-1/2" Specs:

Width:	2', 4' and 6' Panels
Heights:	3' (36") and 3-1/2' (42")
Top Rail:	2-1/2" x 1-1/4"
Bottom Rail:	1-1/2" x 1"
Posts:	2" x 2" x .125 Wall Only 2-1/2" x 2-1/2" x .100 Wall 3" x 3" x .125 Wall 4" x 4" x .125/.250 Wall 6" x 6" x .125/.250 Wall
Pickets:	3/4" x 3/4" x .050 Wall 3/4" Round .065 Wall
Picket Spacing:	3-3/4"
Min. Strength:	35,000 psi
Alum. Alloy:	6005-T5 Alloy (Rails & Posts)

Matching Walk and Drive Gates are also available.

LEGACY 2-1/2" Profiles:

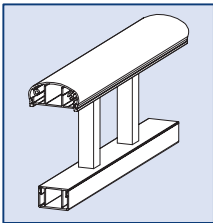

2-1/2" Top Cover
 2-1/2" x 1-1/4"

Available Post to Post and Continuous Top Cover

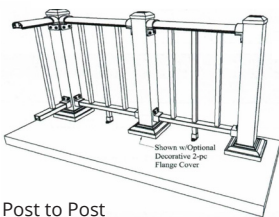

Post to Post

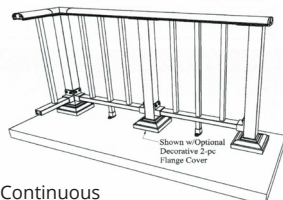

Continuous

LEGACY Colors:

	Textured (Matte) Black		Black		Beige
	Textured (Matte) White		White		Hartford Green
	Textured (Matte) Quaker Bronze		Quaker Bronze		Walnut Brown
	Textured (Matte) Sandstone		Sandstone	Colors shown are simulated and may vary.	

LEGACY Resources:

Specifications, Drawings, Testing/Engineering, Brochure and Warranty

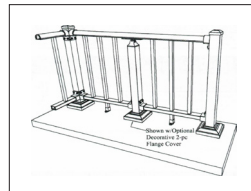

LEGACY 2-1/2" Components:

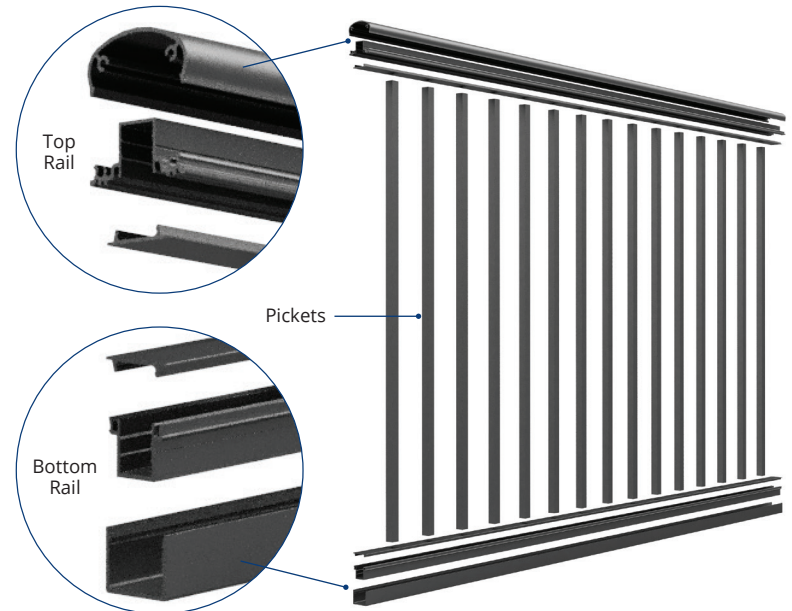

ECO-FRIENDLY



WIND/WEATHER RESISTANT



POWDER COATED
 AAMA 2604-05



LOW MAINTENANCE



LIMITED LIFETIME WARRANTY



BUY AMERICAN
 BE AMERICAN



50925 Richard W. Blvd. | Chesterfield Twp., MI 48051

Phone (586) 468-4448 | Fax (586) 468-4884

1.800.783.1331 | www.EliteFence.com