



PRIVACYGard™ ALUMINUM - T&G 2x3 and 2x6 Vertical and Horizontal

When privacy matters, choose **Elite PRIVACYGard Systems**, part of the **Elite COREGard Architectural Products** brand of **Elite Fence Products**. Our **ALUMINUM** privacy solutions are built from premium aluminum with a minimum strength of 35,000 psi and powder coated to meet the highest AAMA 2604 standards. Designed for lasting performance, they resist rusting, warping and cracking, all without the need for painting or constant upkeep. With clean, modern lines that enhance any property and simple installation, Elite PRIVACYGard delivers both style and strength. Our aluminum PRIVACYGard Fences are tested and engineered using plated and in-ground posts, to ensure high-performance and reliability.

- Vertical and Horizontal Styles
- Hidden Fasteners Provide a Clean Look
- Project-specific Stamped Engineering Drawings Available Upon Request. (Fees May Apply)
- 3-Part Submittals Available
- Uses Include: Pool Fences, Shared Balcony Dividers, Restaurants, Hiding Machinery, Concealing Dumpsters



Buy American, Be American™ 

1.800.783.1331

www.EliteFence.com



PRIVACYGard™ ALUMINUM

T&G 2x3 and 2x6 Vertical and Horizontal

ELITE

COREGard™
ARCHITECTURAL PRODUCTS









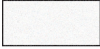

PRIVACYGard Specs*:

Widths:	6' Horizontal and Vertical
Heights:	4', 5', 6', 7' and 8'
Min. Strength:	35,000 psi
Alum. Alloy:	6005-T5 Alloy
Posts:	3", 4" and 6"

Matching Walk and Drive Gates are also available.

*These are the standard specifications. Custom designs may vary.

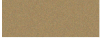
PRIVACYGard Colors:

 Textured (Matte) Black***	 Black	 Beige**
 Textured (Matte) White***	 White	 Hartford Green**
 Textured (Matte) Quaker Bronze***	 Quaker Bronze	 Walnut Brown**
 Textured (Matte) Sandstone***	 Sandstone**	

**These colors have extended lead times.

***Preferred colors for PrivacyGard products.

PRIVACYGard Profiles:

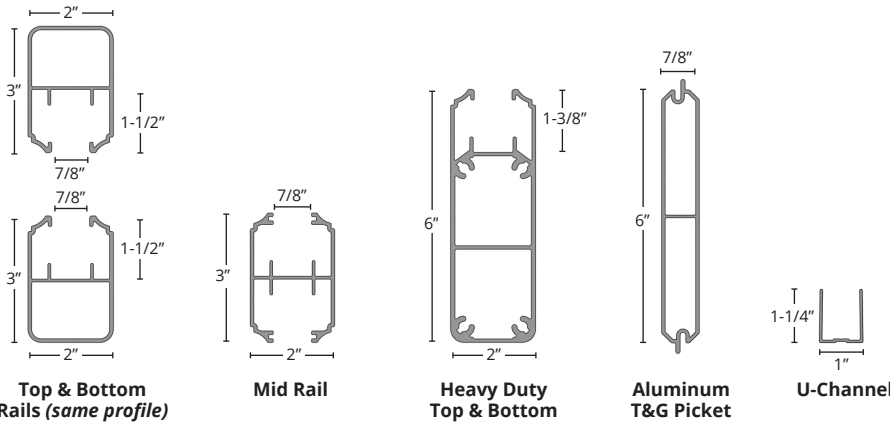

PRIVACYGard Hybrid Resources:

Specifications, Drawings, Testing/Engineering, Brochure and Warranty

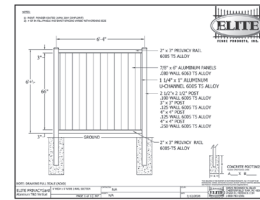

PRIVACYGard Components:

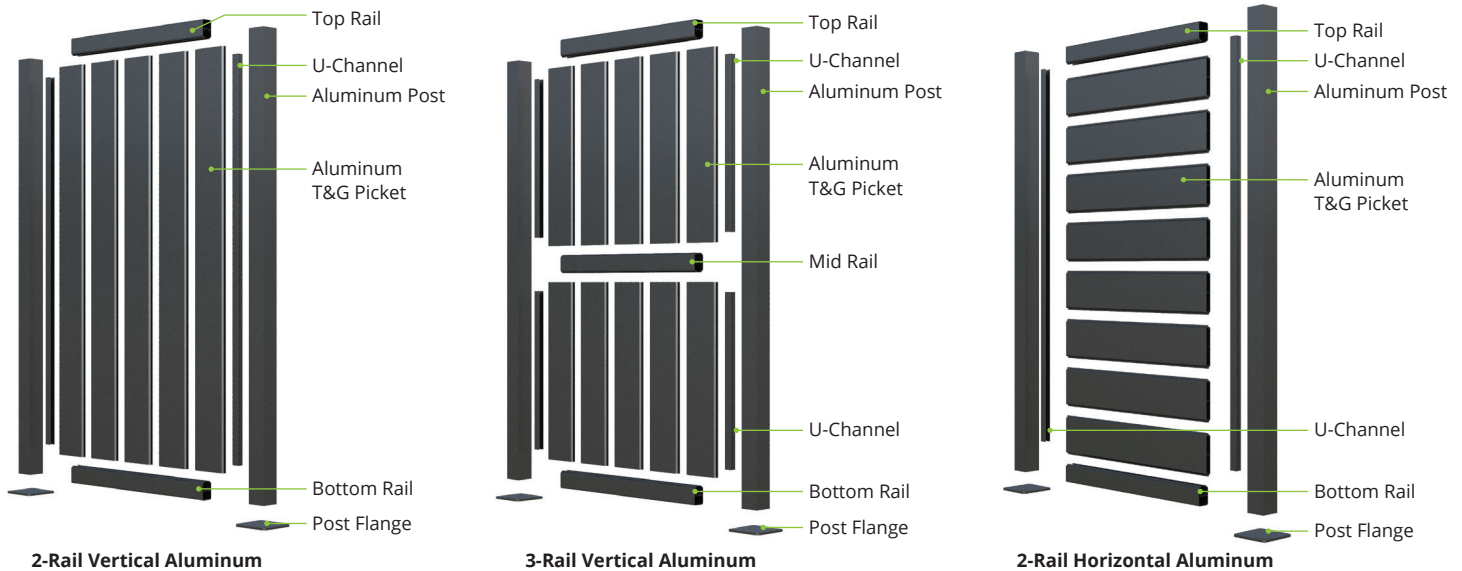

ECO-FRIENDLY



WIND/WEATHER RESISTANT



POWDER COATED AAMA 2604-05



LOW MAINTENANCE



LIMITED LIFETIME WARRANTY



BUY AMERICAN BE AMERICAN

50925 Richard W. Blvd. | Chesterfield Twp., MI 48051

Phone (586) 468-4448 | Fax (586) 468-4884

1.800.783.1331 | www.EliteFence.com

EFR-05ALUMT&G-CTS: REV-B 0526